

APRICUM

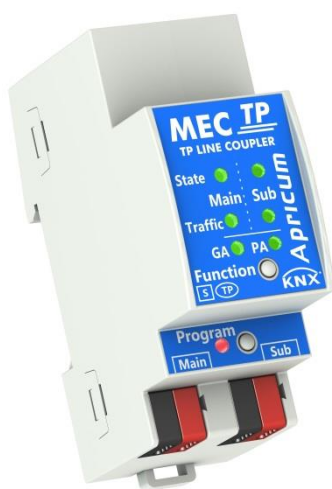

MECtp

KNX Line/Area Coupler/Repeater

Technical & Application Description

This document is property of the company named at the last page. Without written approval, it may not be reproduced or commercialised, distributed or presented to other individuals for commercial purpose. Details and information contained within may be subject to change without notice. For the accuracy of the document no warranty is given. All rights reserved.

Content

| | |
|---|-----------|
| 1 Product Description | 3 |
| 1.1 Front Panel | 4 |
| 1.2 LED Indication | 5 |
| 1.3 Commissioning | 6 |
| 1.4 Feature Summary | 7 |
| 2 Operational Description | 8 |
| 2.1 TP Coupler Application | 8 |
| 2.2 TP Repeater Application | 9 |
| 2.3 KNX Network Installation | 10 |
| 2.3.1 Physical Address | 10 |
| 2.3.2 KNX Topology | 11 |
| 2.4 Programming | 12 |
| 2.4.1 Programming Button | 12 |
| 2.4.2 Physical Address Assignment | 12 |
| 2.5 Special Functions | 13 |
| 2.5.1 Manual Function | 13 |
| 2.5.2 Factory Reset | 13 |
| 3 ETS Database Parameters Coupler | 14 |
| 3.1 General | 14 |
| 3.2 Main Line | 15 |
| 3.3 Subline | 17 |
| 4 ETS Database Parameters Repeater | 19 |
| 4.1 General | 19 |
| 4.2 Main Line | 20 |
| 4.3 Subline | 21 |
| 5 State of Delivery | 22 |
| 5.1 Default Factory Setting | 22 |
| 5.2 Technical Datasheet | 23 |
| 5.3 Technical Drawings | 24 |

1 Product Description

The KNX TP Media Coupler MECtp provides a bi-directional data connection between two KNX TP lines or areas and works as a KNX line/area coupler in the KNX network. KNX TP main line and KNX TP subline are coupled having a galvanic isolation in between. Extended frames and long telegrams with up to 240 bytes APDU length are supported.

Using the TP Coupler application, MECtp can be used as KNX TP line coupler to connect different TP lines, but also as a KNX TP area coupler to connect different TP areas or installation systems via a TP Backbone. Telegram filtering is accomplished according to the installation place in the hierarchy (Physical[ly addressed] Telegrams) and according to the built in filter tables for group communication (Group [oriented] Telegrams). For detailed diagnosis, all operational modes/states are shown by a duo-LED display. Programming on main line from the subline can be suppressed. Number of repetitions on both KNX TP lines can be reduced.

Using the TP Repeater application, MECtp is able to extend a KNX TP line providing unfiltered data transfer and galvanic isolation between segments. Up to four line segments can form a single KNX TP line by connecting three MECtp line repeaters. Each line segment requires its own KNX power supply unit.

To ease commissioning and troubleshooting, special routing/repetition/confirmation ETS settings and a configurable Manual Function for short-time telegram filter switch-off are available. E.g. "transmit all group telegrams" can be activated by a single button press. After the set time period, MECtp switches back to normal operation automatically. Another feature to increase the data throughput is the ability to send IACKs on own telegrams.



In this document, physically addressed telegrams are named Physical Telegrams.



In this document, group oriented telegrams are named Group Telegrams.

1.1 Front Panel

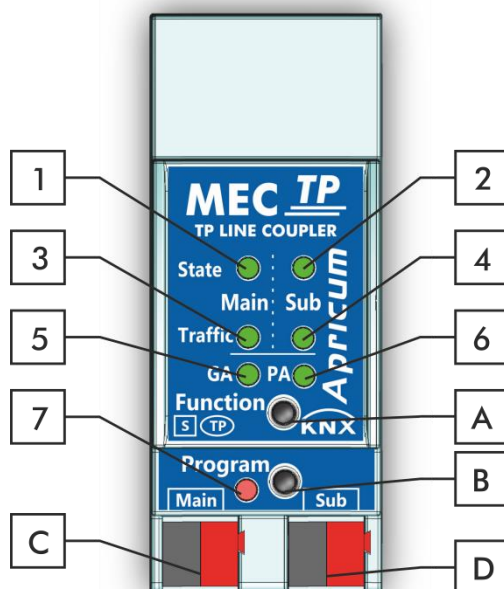

Figure 1: Front View

Table 1: Front Panel Elements

| LEDs | | Buttons / Connectors | |
|----------|-------------------------------------|----------------------|----------------------------|
| 1 | Bus State KNX TP (Main line) | A | Function Button |
| 2 | Bus State KNX TP (Subline) | B | Programming Button |
| 3 | Telegram Traffic KNX TP (Main Line) | C | KNX TP Main Line Connector |
| 4 | Telegram Traffic KNX TP (Subline) | D | KNX TP Subline Connector |
| 5 | Group Address Routing* | | |
| 6 | Physical Address Routing | | |
| 7 | Programming LED | | |

* only group telegrams with main groups 0...13

1.2 LED Indication

If MECtp is used as Line Couper without physical address x.y.0, LED 6 (PA) works not like described here.

Table 2: LEDs Colours

| Number | LED | Colour | Explanation / Range |
|--------|--|----------------|---|
| 1 | Bus State KNX TP (Main line) | green | Main Line OK |
| | | orange | Manual Function active |
| 2 | Bus State KNX TP (Subline) | green | Subline OK |
| | | < off > | Subline not connected |
| 3 | Telegram Traffic KNX TP (Main line) | blinking green | Telegram traffic extent indicated by blinking |
| | | blinking red | Transmission error |
| | | < off > | No telegram traffic |
| 4 | Telegram Traffic KNX TP (Subline) | blinking green | Telegram traffic extent indicated by blinking |
| | | blinking red | Transmission error |
| | | < off > | No telegram traffic |
| 5 | Group Address Routing | green | Filter table active |
| | | orange | Route all |
| | | red | Block all |
| | | < off > | Routing of Group Telegrams is different on main line and subline |
| 6 | Physical Address Routing | green | Filtering active |
| | | orange | Route all |
| | | red | Block all |
| | | < off > | Routing of Physical telegrams is different on main line and subline |
| 7 | Programming LED | red | Programming Mode active |
| | | < off > | Programming Mode not active |

1.3 Commissioning

Please note for commissioning with default settings:

- All telegrams are blocked because the filter table is not defined
- The Manual Function switch-off time is 120 min
- Physical address is 15.15.0

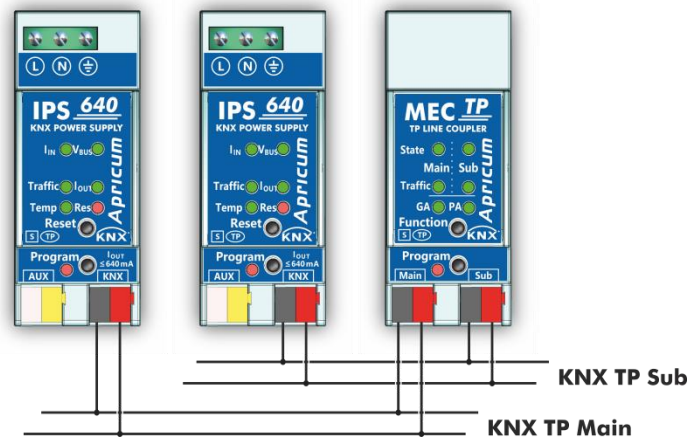

Figure 2: Connection Scheme

Please read carefully before first use:

- After connection to the KNX bus system, the device works with its default settings
- **Warning: Do not connect to 230 V. The device is supplied by the KNX bus and does not require any additional external power supply**
- The device may only be installed and put into operation by a qualified electrician or authorized personnel
- For planning and construction of electric installations the appropriate specifications, guidelines and regulations in force of the respective country have to be complied
- For mounting use an appropriate equipment according to IEC60715
- Installation on a 35 mm DIN rail (TH35)
- Connect the KNX bus line as for common KNX bus connections with a KNX bus cable, to be stripped and plugged into a KNX TP connector
- Do not damage electrical insulations during connecting
- Installation only in dry locations
- Accessibility of the device for operation and visual inspection must be provided
- For changing the configuration use the ETS
- The housing must not be opened
- Protect the device from moisture, dirt and damage
- The device needs no maintenance
- If necessary, the device can be cleaned with a dry cloth
- In the case of damage (at storage, transport) no repairs may be carried out by unauthorized personnel

1.4 Feature Summary

- MECtp supports extended frames and long telegrams up to 240 bytes APDU length. (With all MEC couplers and UIM interfaces long messages e.g. for energy metering applications and visualization purposes can be processed.)
- IACK sending on sent out messages is ETS configurable.
- When there is no IACK response on the subline, MECtp is able to repeat messages up to three times. Repetition can be configured for both Physical Telegrams and Group Telegrams via ETS (to ease troubleshooting). E.g. after an IACK response no repetition is following and the negative IACK/BUSY failure mechanism is maintained.
- For an ETS configurable time period, it is possible to switch off telegram filtering by only pressing a button on the device front panel. Without additional ETS download filtering is suspended. This is necessary for running fast diagnostics on site.
- Suspending telegram filtering eases commissioning and debugging. When filtering is suspended, temporary access to other lines becomes possible.
- Automatic function for switching back to run-time telegram filtering after configurable suspension period (see Manual Mode). This avoids forgetting the reactivation of filtering.
- In networks with high busload the internal amount of communication buffers are capable of smoothing peaks in the communication load course.
- MECtp's ETS database entries are available for ETS4 and later.

2 Operational Description

In network installations MECtp can be used as KNX TP area/line coupler or KNX TP line repeater. After connecting the main line to KNX TP, MECtp operates with its default settings. Setting the correct physical address is necessary to include MECtp in the present KNX bus system. Only physical addresses x.y.0 are allowed to be set.

2.1 TP Coupler Application

When MECtp receives telegrams (for example during commissioning) that use Physical Addresses as destination addresses, it compares the Physical Addresses of the receiver with its own physical address and decides on that whether it has to route the telegrams or not.

When MECtp receives telegrams that use group addresses as destination addresses, it reacts in accordance with the parameter settings. During normal operation (with Group Telegram routing set to filter), MECtp only routes telegrams whose group addresses are entered in its filter table.

If a telegram is routed by MECtp without receiving the corresponding acknowledgement, i.e. due to a missing receiver or to a transmission error, the telegram will be repeated up to three times (depending on the ETS setting). With the parameters „Repetitions if errors...“, this function can be configured separately for each line and both kinds of telegrams. It is recommended to use the default parameter setting.

If not already configured as “Line Coupler”, the ETS application program “TP Coupler” has to be downloaded to the device. Under the Information tab the configuration setting can be changed by the drop-down menu “Change Application Program”. After changing the configuration setting the filter table entries can be added manually. Updating the application program version can also be done here.

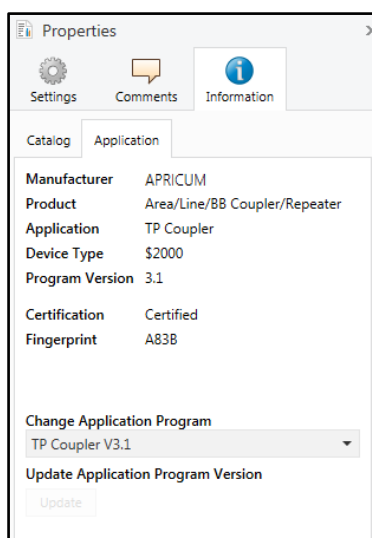

Figure 3: TP Coupler Application Program

2.2 TP Repeater Application

Any received telegram is routed to all lines irrespective of in which line it is processed. Line repeaters make no use of a filter table. It is therefore not important whether the telegram is generated within a line or whether it is sent from an upper line to a lower line via a coupler.

If a telegram is routed by MECtp without receiving the corresponding acknowledgement, i.e. due to a missing receiver or to a transmission error, the telegram will be repeated up to three times (depending on the ETS setting). With the parameters „Repetitions if errors...“, this function can be configured separately for each line and both kinds of telegrams. It is recommended to use the default parameter setting.

If not already configured as Line/Area/BB Repeater, the ETS application program “TP repeater” has to be downloaded to the device. Under the Information tab the configuration setting can be changed by the drop-down menu “Change Application Program”. After changing the configuration setting the filter table entries can be added manually. Updating the application program can also be done here.

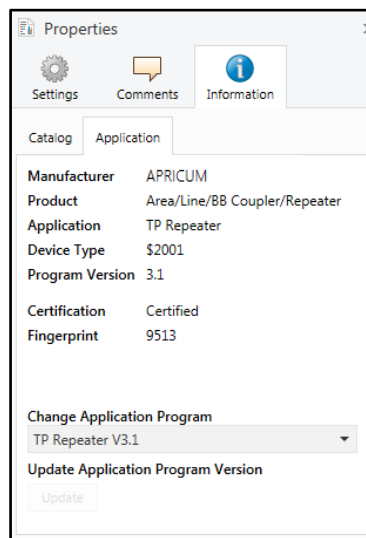

Figure 4: TP Repeater Application Program

2.3 KNX Network Installation

2.3.1 Physical Address

For line coupler functionality in a KNX network MECtp has to use the correct Physical Address of a line coupler (x.y.0, $1 \leq x \text{ \& \ } y \leq 15$). In ETS up to 225 addresses can be defined (from 1.1.0 to 15.15.0).

For area coupler functionality in a KNX network MECtp has to use the correct Physical Address of an area coupler (x.0.0, $1 \leq x \leq 15$). In ETS up to 15 areas can be defined.

If MECtp is used in a KNX system for both purposes, it is only necessary to ensure that the MECtp used as a line coupler has a line coupler address assigned from a free addressing area. Following figure illustrates the MECtp router topology for KNX lines and KNX areas.

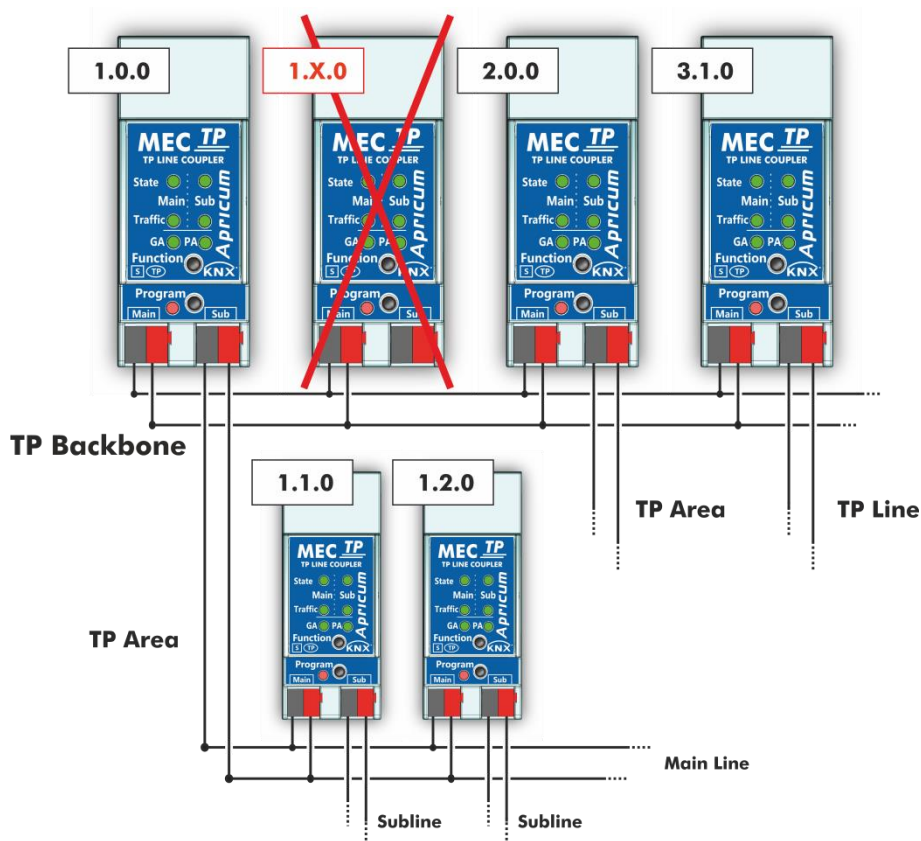

Figure 5: MECtp Network

Example: If an area coupler with address 1.0.0 already exists on the backbone no line coupler with address 1.x.0, $1 \leq x \leq 15$ can be added here. Even if no line coupler with address 1.1.0 exists on the subline of the 1.0.0 area coupler. Vice versa, if a line coupler with address 1.1.0 already exists in the installation no area coupler with address 1.0.0 can be added.

2.3.2 KNX Topology

Via a line/area coupler up to 15 lines can be connected to a main line called an area. It is possible to have up to 64 bus devices on one line. With use of line repeaters a line can theoretically be extended to 255 bus devices. This means up to four line segments form a single KNX TP line. But it is common practice on exceeding 64 bus devices to insert a new line instead of extending the originating one.

The free tree structure of the KNX topology prevents problems caused by circling telegrams and heavy bus load. To maintain this condition, interconnection between lines or line segments is strictly forbidden.

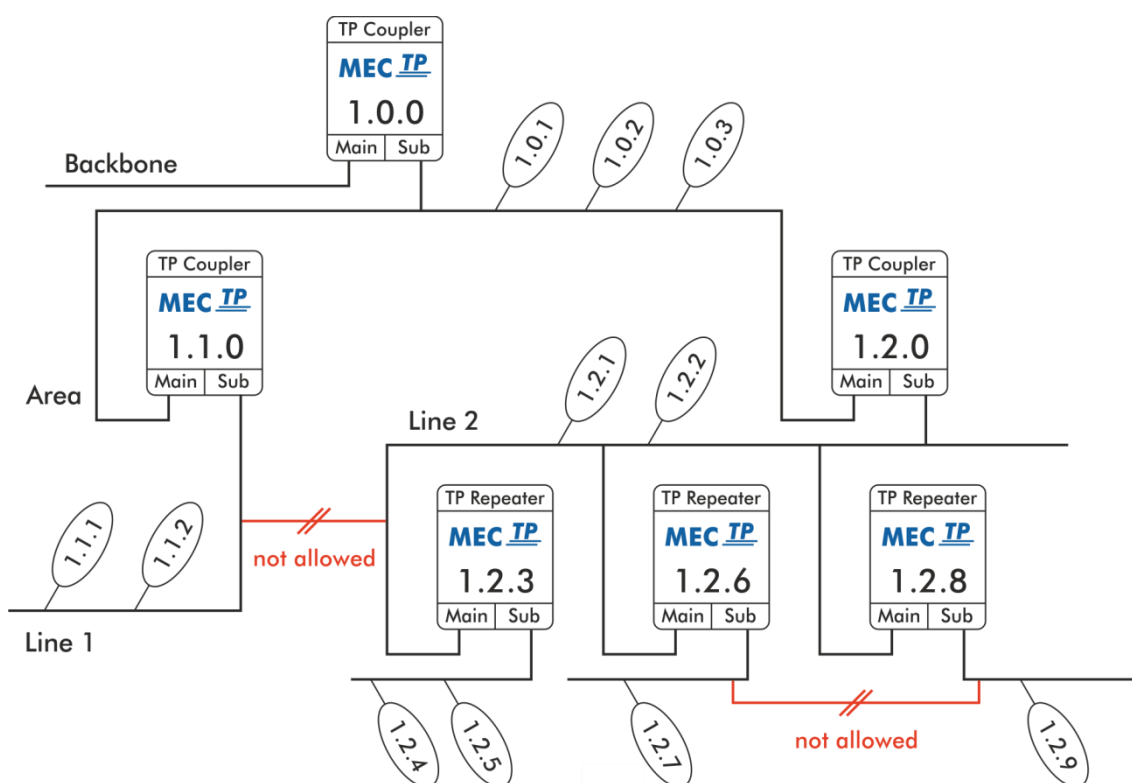





Figure 6: MECtp Network Topology

-  Each line segment requires its own KNX power supply unit.
-  Using repeaters on and main lines is not allowed.
-  Interconnections are not allowed

2.4 Programming

2.4.1 Programming Button

To download the desired physical address or an ETS setting the Programming Mode must be activated. Successive pressing the Programming Button will turn on and off the Programming Mode. LED 7 lighting in red colour indicates Programming Mode is active. When Programming Mode is activated, the ETS is able to download the physical address.

2.4.2 Physical Address Assignment

To configure the device an interface connection (IP, USB) to the KNX bus system is required. The device is supplied with the individual physical address 15.15.0. The KNX product database entry (available for ETS3.0d and higher) can be downloaded from the Apricum website and from the KNX Online Catalog.

The physical address can be assigned to the device by setting the desired address in the properties window of the ETS. After starting the ETS download and then pressing the Programming Button the device restarts itself.

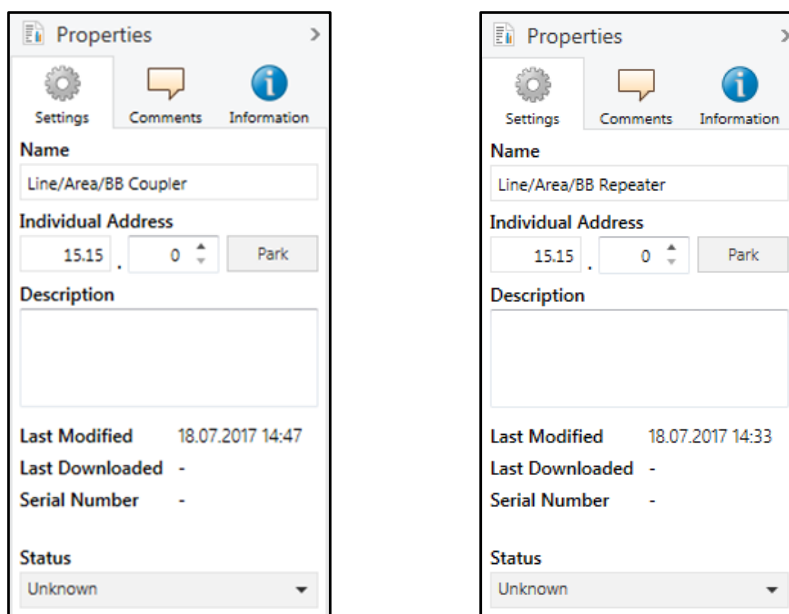

Figure 7: ETS Properties Window



In this document only the term “physical address” is used. The term “physical address” means the KNX physical address as well as the ETS individual address. Both terms are used by the KNX organisation interchangeably.

2.5 Special Functions

The Function Button activates MECtp's special functions. Manual Function and Factory Reset can be activated. It depends on time the Function Button is being pressed.

2.5.1 Manual Function

During normal operation a rather short press (≈ 3 sec) activates and deactivates the Manual Function. LED 5 and LED 6 show the current filtering states.

When the Manual Function is active, either all Physical Telegrams or all Group Telegrams or both pass the MECtp without filtering. After the Switch-off time period has elapsed, MECtp automatically switches back to normal operation. To configure the Manual Function and set the Switch-off time use the General parameter tab like shown in chapters 3.1 and 4.1. After switching back from Manual Function to normal operation the latest downloaded parameter setting / filter table entries are active again.

2.5.2 Factory Reset

A long press (≈ 15 sec) of the Function Button soon followed by a short press (≈ 3 sec) executes the Factory Reset. After the first press, the LED display lights like described in Table 4. After the second press, all parameters will be set to factory default (incl. physical address). Subsequently, LEDs show the normal operation display again.

2.5.3 LED Status Display

Table 3: LED Status Display for Manual Function

| Number | LED | Colour | Comment |
|--------|------------------------------|-------------------------------------|-------------------------------|
| 1 | Bus State KNX TP (Main line) | orange | |
| 2 | Bus State KNX TP (Subline) | green | LED is <off> if not connected |
| 5 | Group Address Routing | green: filter | |
| 6 | Physical Address Routing | orange: route all red: block all | |





Table 4: LED Status Display for Factory Reset after first Button Press

| Number | LED | Colour | Comment |
|--------|------------------------------|-------------------------------------|---------------------------------|
| 1 | Bus State KNX TP (Main line) | orange | |
| 2 | Bus State KNX TP (Subline) | orange | LED lights red if not connected |
| 5 | Group Address Routing | green: filter | |
| 6 | Physical Address Routing | orange: route all red: block all | |



3 ETS Database Parameters Coupler

All screen shots are related to the MECtp database V3.1 in ETS5.

3.1 General

Figure 8: General Tab Parameters

Table 5: General Tab Parameter Settings

| ETS Parameter | Setting [Factory Default] | Comment |
|-------------------------------------|---|---|
| Manual Function | disabled pass all telegrams pass all Physical telegrams pass all Group telegrams [pass all telegrams] | Configuration setting for telegram routing when the Manual Function is active. |
| Switch-off time for Manual Function | 10 min, 1 hour, 4 hours, 8 hours [1 hour] | After expiry of this time period the Manual Function is switched off automatically. |

3.2 Main Line

For Group Telegrams and Physical Telegrams the setting “transmit all” is intended only for testing purposes. Please do not use for normal operation.



If the parameter “Send confirmation on own telegrams” is set to “yes”, the MECtp systematically sends an ACK on any own routed telegram.

Figure 9: Main Line Tab Parameters

Table 6: Main Line Tab Parameter Settings

| ETS Parameter | Setting [Factory Default] | Comment |
|-------------------------------------|--|--|
| Telegram routing | Group: filter, Physical: block Group and Physical: filter Group: route, Physical: filter Group and Physical: route configure [Group and Physical: filter] | block: no telegrams are routed. |
| | | filter: telegrams entered in the filter table are routed. |
| | | route: all telegrams are routed. |
| | | configure: the following parameters must be set manually. |
| Group telegrams: Main group 0...13 | transmit all (not recommended) block filter [filter] | <ul style="list-style-type: none"> Group telegrams (main group 0...13) are all routed. Group telegrams (main group 0...13) are all blocked. Group telegrams (main group 0...13) are routed if entered in the filter table. |
| | | <ul style="list-style-type: none"> Group telegrams (main group 14...31) are all routed. Group telegrams (main group 14...31) are all blocked. Group telegrams (main group 14...31) are routed if entered in the filter table. |
| | | <ul style="list-style-type: none"> Physical telegrams are all routed. Physical telegrams are all blocked. Depending on the physical address Physical telegrams are routed. |
| Group telegrams: Main group 14...31 | transmit all (not recommended) block filter [filter] | <ul style="list-style-type: none"> Physical telegrams are all routed. Physical telegrams are all blocked. Depending on the physical address Physical telegrams are routed. |
| Physical telegrams | transmit all (not recommended) block filter [filter] | <ul style="list-style-type: none"> Physical telegrams are all routed. Physical telegrams are all blocked. Depending on the physical address Physical telegrams are routed. |

| ETS Parameter | Setting [Factory Default] | Comment |
|--|---|--|
| Physical telegrams: Repetition if errors on main line | no up to 3 repetitions only one repetition [up to 3 repetitions] | After main line transmission error (e.g. due to missing receiver) Physical telegrams <ul style="list-style-type: none"> • are not repeated. • are repeated max. 3 times. • are repeated once. |
| Group telegrams: Repetition if errors on main line | no up to 3 repetitions only one repetition [up to 3 repetitions] | After main line transmission error (e.g. due to missing receiver) Group telegrams <ul style="list-style-type: none"> • are not repeated. • are repeated max. 3 times. • are repeated once. |
| Telegram confirmation on main line | if routed always [if routed] | <ul style="list-style-type: none"> • Routed telegrams to the subline are confirmed by an ACK on the main line. • Each telegram on the mainline is confirmed by an ACK. |
| Send confirmation on own telegrams | yes no [no] | <ul style="list-style-type: none"> • Telegrams sent out to the mainline are confirmed by added ACK. • No ACK confirmation. |

3.3 Subline

For Group Telegrams and Physical Telegrams the setting “transmit all” is intended only for testing purposes. Please do not use for normal operation.

Figure 10: Subline Tab Parameters

Table 7-1: Subline Tab Parameter Settings

| ETS Parameter | Setting [Factory Default] | Comment |
|--|--|--|
| Telegram routing | Group: filter, Physical: block Group and Physical: filter Group: route, Physical: filter Group and Physical: route configure [Group and Physical: filter] | block: no telegrams are routed. |
| | | filter: telegrams entered in the filter table are routed. |
| | | route: all telegrams are routed. |
| | | configure: the following parameters must be set manually. |
| Group telegrams: Main group 0...13 | transmit all (not recommended) block filter [filter] | <ul style="list-style-type: none"> Group telegrams (main group 0...13) are all routed. Group telegrams (main group 0...13) are all blocked. Group telegrams (main group 0...13) are routed if entered in the filter table. |
| | | <ul style="list-style-type: none"> Group telegrams (main group 14...31) are all routed. Group telegrams (main group 14...31) are all blocked. Group telegrams (main group 14...31) are routed if entered in the filter table. |
| Group telegrams: Main group 14...31 | transmit all (not recommended) block filter [filter] | <ul style="list-style-type: none"> Physical telegrams are all routed. Physical telegrams are all blocked. Depending on the physical address Physical telegrams are routed. |
| | | After subline transmission error (e.g. due to missing receiver) Physical telegrams <ul style="list-style-type: none"> are not repeated. are repeated max. 3 times. are repeated once. |
| Physical telegrams | transmit all (not recommended) block filter [filter] | |
| Physical telegrams: Repetition if errors on subline | no up to 3 repetitions only one repetition [up to 3 repetitions] | |

| ETS Parameter | Setting [Factory Default] | Comment |
|---|---|---|
| Group telegrams: Repetition if errors on subline | no up to 3 repetitions only one repetition [up to 3 repetitions] | After subline transmission error (e.g. due to missing receiver) Group telegrams <ul style="list-style-type: none"> • are not repeated. • are repeated max. 3 times. • are repeated once. |
| Telegram confirmation on subline | if routed always [if routed] | <ul style="list-style-type: none"> • Routed telegrams to main line are confirmed by an ACK on the subline. • Each telegram on the subline is confirmed by an ACK. |
| Send confirmation on own telegrams | yes no [no] | <ul style="list-style-type: none"> • Telegrams sent out to the subline are confirmed by added ACK. • No ACK confirmation. |
| Configuration from subline | allow block [allow] | If blocked an ETS download to the MECtp can occur only via main line. |

4 ETS Database Parameters Repeater

All screen shots are related to the MECtp database file R3-0b in ETS5.

4.1 General

Figure 11: General Tab Parameters

Table 8: General Tab Parameter Settings

| ETS Parameter | Setting [Factory Default] | Comment |
|-------------------------------------|---|---|
| Manual Function | disabled pass all telegrams pass all Physical telegrams pass all Group telegrams [pass all telegrams] | Configuration setting for telegram routing when the Manual Function is active. |
| Switch-off time for Manual Function | 10 min, 1 hour, 4 hours, 8 hours [1 hour] | After expiry of this time period the Manual Function is switched off automatically. |

4.2 Main Line

For Group Telegrams and Physical Telegrams the setting “transmit all” is intended only for testing purposes. Please do not use for normal operation.



If the parameter “Send confirmation on own telegrams” is set to “yes”, the MECtp systematically sends an ACK on any own routed telegram. Since the repeater does not use a filter table, it is useful to have an ACK sent along with routed telegrams.

15.15.1 Area/Line/BB Coupler/Repeater > Main line

| | | |
|-----------|---|--|
| General | Telegram routing | <input type="radio"/> Group and Physical: route <input checked="" type="radio"/> configure |
| Main line | Physical telegrams | <input checked="" type="radio"/> transmit all <input type="radio"/> block |
| Subline | Physical telegrams: Repetition if errors on main line | only one repetition |
| | Group telegrams: Repetition if errors on main line | only one repetition |
| | Telegram confirmation on main line | <input type="radio"/> if routed <input checked="" type="radio"/> always |
| | Send confirmation on own telegrams | <input checked="" type="radio"/> yes <input type="radio"/> no |

Figure 12: Main Line Tab Parameters

Table 9: Main Line Tab Parameter Settings

| ETS Parameter | Setting [Factory Default] | Comment |
|---|---|--|
| Telegram routing | Group and Physical: route configure [Group and Physical: route] | route: all telegrams are routed. configure: the following parameters must be set manually. |
| Physical telegrams | transmit all block [transmit all] | <ul style="list-style-type: none"> Physical telegrams are all routed. Physical telegrams are all blocked. |
| Physical telegrams: Repetition if errors on main line | no up to 3 repetitions only one repetition [only one repetition] | After main line transmission error (e.g. due to missing receiver) Physical telegrams <ul style="list-style-type: none"> are not repeated. are repeated max. 3 times. are repeated once. |
| Group telegrams: Repetition if errors on main line | no up to 3 repetitions only one repetition [only one repetition] | After main line transmission error (e.g. due to missing receiver) Group telegrams <ul style="list-style-type: none"> are not repeated. are repeated max. 3 times. are repeated once. |
| Telegram confirmation on main line | if routed always [always] | <ul style="list-style-type: none"> Routed telegrams to the subline are confirmed by an ACK on the main line. Each telegram on the mainline is confirmed by an ACK. |
| Send confirmation on own telegrams | yes no [yes] | <ul style="list-style-type: none"> Telegrams sent out to the mainline are confirmed by added ACK. No ACK confirmation. |

4.3 Subline

For Group Telegrams and Physical Telegrams the setting “transmit all” is intended only for testing purposes. Please do not use for normal operation.

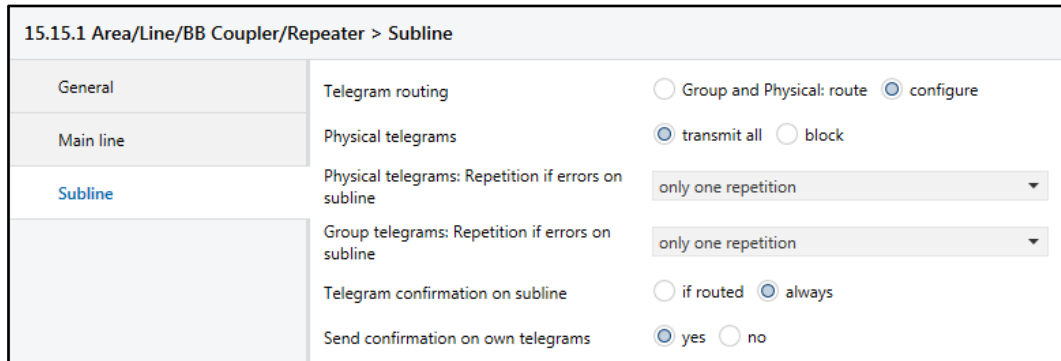

Figure 13: Subline Tab Parameters

Table 10-1: Subline (KNX TP) Tab Parameter Settings

| ETS Parameter | Setting [Factory Default] | Comment | |
|--|---|--|--|
| Telegram routing | Group and Physical: route configure [Group and Physical: route] | route: | all telegrams are routed. |
| | | configure: | the following parameters must be set manually. |
| Physical telegrams | transmit all block [transmit all] | <ul style="list-style-type: none"> Physical telegrams are all routed. Physical telegrams are all blocked. | |
| Physical telegrams: Repetition if errors on subline | no up to 3 repetitions only one repetition [only one repetition] | After subline transmission error (e.g. due to missing receiver) Physical telegrams <ul style="list-style-type: none"> are not repeated. are repeated max. 3 times. are repeated once. | |
| Group telegrams: Repetition if errors on subline | no up to 3 repetitions only one repetition [only one repetition] | After subline transmission error (e.g. due to missing receiver) Group telegrams <ul style="list-style-type: none"> are not repeated. are repeated max. 3 times. are repeated once. | |
| Telegram confirmation on subline | if routed always [always] | <ul style="list-style-type: none"> Routed telegrams to main line are confirmed by an ACK on the subline. Each telegram on the subline is confirmed by an ACK. | |
| Send confirmation on own telegrams | yes no [yes] | <ul style="list-style-type: none"> Telegrams sent out to the subline are confirmed by added ACK. No ACK confirmation. | |

5 State of Delivery

5.1 Default Factory Setting

Table 11: Default Factory Setting

| General | |
|---|--------------------------------|
| Physical Address | 15.15.0 |
| Main line | |
| Group telegrams (main group 0...13) | filter (filter table is empty) |
| Group telegrams (main group 14...31) | route all |
| Physical telegrams | filter |
| Physical: Repetition if errors on main line | up to 3 repetitions |
| Group: Repetition if errors on main line | up to 3 repetitions |
| Telegram confirmations on main line | if routed |
| Send confirmation on own telegrams | no |
| Subline | |
| Group telegrams (main group 0...13) | filter (filter table is empty) |
| Group telegrams (main group 14...31) | route all |
| Physical telegrams | filter |
| Physical: Repetition if errors on subline | up to 3 repetitions |
| Group: Repetition if errors on subline | up to 3 repetitions |
| Telegram confirmations on subline | if routed |
| Send confirmation on own telegrams | no |
| Configuration from subline | allow |

5.2 Technical Datasheet

| | |
|------------------------------|---|
| Marking/Design | MECtp |
| Current consumption | < 10 mA |
| Connections | <p>KNX TP main line: KNX TP connector (red/black), screwless, for single-core cable Ø 0.6...0.8 mm</p> <p>KNX TP subline: KNX TP connector (red/black), screwless, for single-core cable Ø 0.6...0.8 mm</p> |
| LED Display elements | <p>State (Main and Sub)</p> <p>Traffic (Main and Sub)</p> <p>Routing (GA and PA)</p> <p>Programming LED</p> |
| Control elements | <p>Function Button</p> <p>Programming Button</p> |
| Mounting | 35 mm top-hat rail (TH35) according to IEC60715 |
| Protection type | IP20 according to IEC60529 |
| Pollution degree | 2 according to IEC60664-1 |
| Protection class | III according to IEC61140 |
| Overvoltage category | III according to IEC60664-1 |
| Approbation | KNX-certified according to ISO/IEC14543-3 |
| CE Marking | In compliance with directives 2014/35/EU (LVD), 2014/30/EU (EMC), 2011/65/EU (RoHS) |
| Standards | EN50491-5-1, EN50491-5-2, EN50491-5-3, EN50581, EN61000-6-2, EN61000-6-3 |
| Voltage supply | KNX: 21...30V DC (SELV) |
| Housing colour | Plastic PA66 housing, grey |
| Housing dimensions | H = 90 mm, W = 36 mm (2 modules), D = 71 mm |
| Mounting depth | 64 mm |
| Weight | 62 g |
| Operating temperature | -5...45 °C |
| Storage temperature | -20...60 °C |
| Ambient humidity | 5...93 %, non-condensing |

5.3 Technical Drawings



All dimensions shown here are specified in mm.



The total device width is 2 modules at 18 mm.

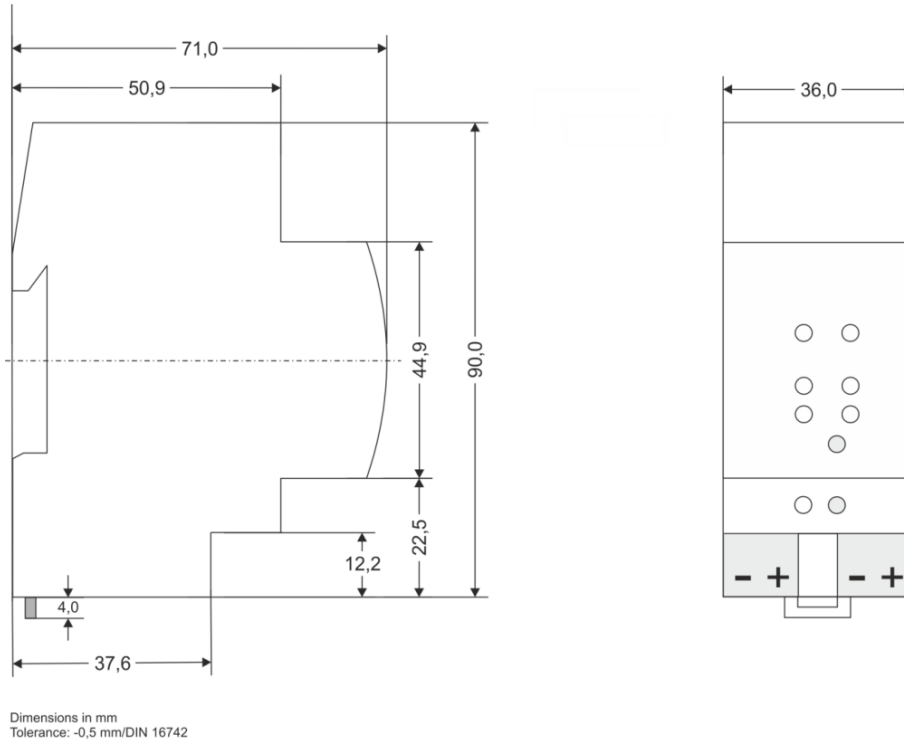

Figure 14: Dimension drawings

MECtp

Product:

KNX Line/Area Coupler/Repeater

Doctype:

Technical & Application Description

Release Number / Release Date:

R3.5 / April 2019

Editor:

Peter Hauner

Web:

www.apricum.com/mectp

Contact:

apricum@apricum.com

Telephone:

+385 21 507600