

APRICUM



UIMip

KNX IP Interface

Technical & Application Description

This document is property of the company named at the last page. Without written approval, it may not be reproduced or commercialised, distributed or presented to other individuals for commercial purpose. Details and information contained within may be subject to change without notice. For the accuracy of the document no warranty is given. All rights reserved.

Content

1	Product Description	3
1.1	Front Panel	4
1.2	LED Indication	5
1.3	Commissioning	6
1.4	Feature Summary	7
2	KNXnet/IP	8
2.1	IP Tunneling	8
2.2	IP Routing	8
2.3	IP Bootloader / Boot Mode	8
3	Operational Description	9
3.1	IP Interface Application	9
3.2	IP Network	10
3.3	Programming	11
3.3.1	Programming Button	11
3.3.2	Physical Address Assignment	11
3.4	Function Button	12
3.4.1	Factory Reset	12
3.4.2	Boot Mode Activation	12
3.4.3	LED Status Display	13
4	ETS Database Parameters	14
4.1	General	14
4.2	IP Configuration	15
5	Web Front-end	16
5.1	Accessing the UIMip Web Front-end	16
5.1.1	via Windows Network UPnP	16
5.1.2	via IP Address	17
5.1.3	via MAC Address	17
5.2	Device Info	18
5.3	KNX	19
5.4	Firmware Update / Boot Mode	20
5.5	IP Tunneling Address Assignment	22
6	State of Delivery	23
6.1	Default Factory Setting	23
6.2	Technical Datasheet	24
6.3	Technical Drawings	25
7	Legal Notice	26
8	FAQ	27

1 Product Description

The KNX IP Interface UIMip provides a bi-directional Ethernet/IP data connection to the KNX TP bus system. A PC having a LAN adapter, an Ethernet network or KNX IP devices can be connected to KNX TP having a galvanic isolation in between. UIMip establishes access to all bus devices featuring commissioning, addressing, setting parameters, visualization, protocolling, and diagnostic operation. For detailed diagnosis all operational modes/states are shown by a duo-LED display. UIMip is completely supplied by KNX TP. So, no additional external power supply is necessary.

With the ETS (or compatible commissioning tool) UIMip works as the KNX programming interface having no KNX communication objects for itself. Connecting a personal computer to the KNX TP bus can ideally be done via Ethernet/Internet. The protocols used for communication between interface and host are the flexible “cEMI” protocol and the KNXnet/IP protocol. UIMip supports extended frames and long messages with up to 240 byte APDU length. Easy software handling is ensured by the Falcon driver.

For IP Tunneling, up to four tunneling addresses can be used. With the comfortable web front-end of UIMip, it possible to remotely read out actual device info, set addresses for tunneling, activate Programming Mode, and update the firmware via IP. It is easy to identify UIMip in a network by remotely switching on its Programming LED.



In this document, physically addressed telegrams are named Physical Telegrams.



In this document, group oriented telegrams are named Group Telegrams.

1.1 Front Panel

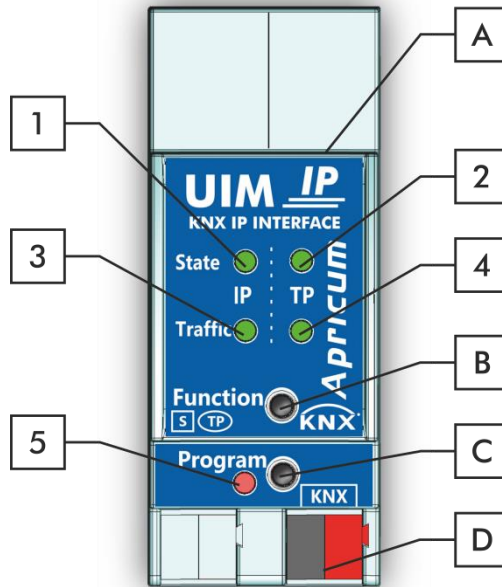

Figure 1: Front View

Table 1: Front Panel Elements

LEDs		Buttons / Connectors	
1	IP State	A	Ethernet Connector
2	Bus State KNX TP	B	Function Button
3	Telegram Traffic IP	C	Programming Button
4	Telegram Traffic KNX TP	D	KNX TP Connector
5	Programming LED		

1.2 LED Indication

Table 2: LEDs Colours

Number	LED	Colour	Explanation / Range
1	IP State	green	IP line OK
		< off >	No IP connection
2	Bus State KNX TP	green	KNX TP line OK
		< off >	KNX TP line not connected
3	Telegram Traffic IP	blinking green	Telegram traffic extent indicated by blinking
		blinking red	Transmission error
		< off >	No telegram traffic
4	Telegram Traffic KNX TP	blinking green	Telegram traffic extent indicated by blinking
		blinking red	Transmission error
		< off >	No telegram traffic
5	Programming LED	red	Programming Mode / Boot Mode active
		blinking red	No IP connection
		< off >	Programming Mode / Boot Mode not active

1.3 Commissioning

Please note for commissioning with default settings:

- Physical address is 15.15.0

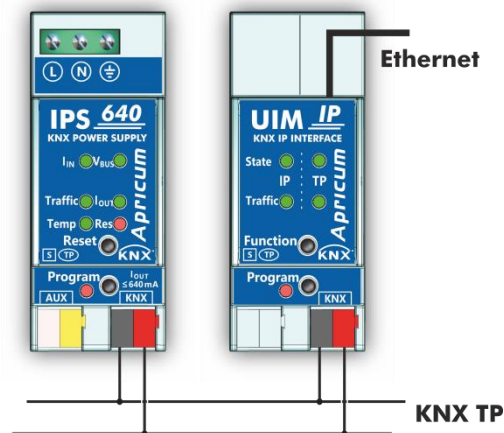

Figure 2: Connection Scheme

Please read carefully before first use:

- After connection to the KNX bus system, the device works with its default settings
- **Warning: Do not connect to 230 V. The device is supplied by the KNX bus and does not require any additional external power supply**
- The device may only be installed and put into operation by a qualified electrician or authorized personnel
- For planning and construction of electric installations the appropriate specifications, guidelines and regulations in force of the respective country have to be complied
- For mounting use an appropriate equipment according to IEC60715
- Installation on a 35 mm DIN rail (TH35)
- Connect the KNX bus line as for common KNX bus connections with a KNX bus cable, to be stripped and plugged into a KNX TP connector
- Do not damage electrical insulations during connecting
- Installation only in dry locations
- Accessibility of the device for operation and visual inspection must be provided
- For changing the configuration use the ETS
- The housing must not be opened
- Protect the device from moisture, dirt and damage
- The device needs no maintenance
- If necessary, the device can be cleaned with a dry cloth
- In the case of damage (at storage, transport) no repairs may be carried out by unauthorized personnel

1.4 Feature Summary

- UIMip supports extended frames and long telegrams up to 240 bytes APDU length. (With all MEC couplers and UIM interfaces long messages e.g. for energy metering applications and visualization purposes can be processed.)
- UIMip works without external power supply.
- For IP Tunneling, four different tunneling connections, with a separate address for each, can be realized in parallel. Quick assignment can be done by the web front-end.
- UPnP is available to discover the device within the IP network. This can only be realized by a proper network installation in terms of topology. With use of KNXnet/IP ETS is able to recognize the communication interface device.
- Updating the firmware can easily be accomplished by a web browser. The available web front-end provides informative settings and enables to remotely switch the device into Programming Mode without use of the Programming Button.
- In networks with high busload the internal amount of communication buffers are capable of smoothing peaks in the communication load course.
- In the web front-end, a diagram of a 60 min busload history can be watched.
- UIMip's ETS database entries are available for ETS4 and later.
- UIMip supports KNXnet/IP, ARP, ICMP, IGMP, HTTP, UPnP discovery, UDP/IP, TCP/IP, DHCP und AutoIP.

2 KNXnet/IP

UIMip is a KNX IP interface. KNX IP interfaces are highly similar to USB interfaces. The only difference is that they use the IP communication medium and the KNXnet/IP communication protocol. However, KNX end devices can be integrated directly via IP. This makes the Ethernet a real KNX medium.

As documented in the KNXnet/IP protocol specifications, KNX telegrams can be transmitted encapsulated in IP packets. Ethernet networks as well as Internet can be used to route or tunnel KNX telegrams. In this way, IP interfaces and IP routers are an alternative to USB data interfaces and TP line/area/backbone couplers, respectively. In the latter case, a TP backbone can be completely replaced by a fast Ethernet based line then called IP backbone.

2.1 IP Tunneling

The presence of the Internet Protocol (IP) has led to the definition of the KNXnet/IP protocol. KNXnet/IP offers the possibility for point-to-point connections for the ETS (KNXnet/IP Tunneling) and/or between supervisory system and KNX installation. The KNXnet/IP device management enables KNXnet/IP device configuring via the KNX network in order to reduce the time required for complete network configuration.

2.2 IP Routing

IP Routing is the way of interconnecting KNX lines and areas by IP network(s) via KNXnet/IP. In IP networks, the KNXnet/IP Routing defines the way of KNXnet/IP router communication.

2.3 IP Bootloader / Boot Mode

The IP bootloader function is used to update the firmware and completely rewrite the flash memory content. This is not just a simple application download. Both communication stack and application software are downloaded.

The firmware update procedure via IP is executed by a web front-end, which is independent from ETS, and makes use of special messages to speed up the process. To be protected, their contents are encrypted.



Entering Boot Mode is equivalent to activating the IP bootloader function.

3 Operational Description

In network installations UIMip is used as KNX IP interface. After connecting to KNX TP, UIMip operates with its default settings. Setting the correct physical address is necessary to include UIMip in the present KNX bus system.

3.1 IP Interface Application

IP Interface is designed for use in 10/100 BaseT networks compliant to IEEE802.3. The AutoSensing function sets the baud rate (10 Mbit or 100 Mbit) automatically. IP address can be received from a DHCP server. For this, the automatic assignment setting of the IP address can be set by ETS (use DHCP). If set so and no DHCP server is found, UIMip starts an AutoIP procedure and autonomously assigns the IP address. The IP address that UIMip receives during its start-up (via DHCP or AutoIP) is retained until next start-up (e.g. due to power off or reprogramming). If UIMip is supposed to have a fixed IP address (as well as subnet mask and standard gateway) it can be set by ETS.



ETS does not provide an unload procedure for applications.

3.2 IP Network

UIMip sends telegrams from/to the TP network to/from the IP network in accordance with the KNXnet/IP protocol specification. Important notes:

- All KNX IP devices that are intended to communicate with each other via IP must have the same IP multicast address.
- If the IP address is changed from the IP side it may happen that ETS does no longer recognize the device and connection cannot be maintained (tunneling uses IP addresses). So, it is recommended to change IP addresses and restart only from TP side.
- If problems occur for IP address assignment please ask your network administrator.
- According to the topology, the Tunneling addresses always have to be assigned in the range of subline addresses. For more information about additional physical addresses for tunneling please refer to IP Tunneling Address Assignment.
- To program devices of a line different to which the device used for (re)programming is connected, the use of a correct topology is mandatory!

3.3 Programming

3.3.1 Programming Button

To download the desired physical address or an ETS setting the Programming Mode must be activated. Successive pressing the Programming Button will turn on and off the Programming Mode. LED 7 lighting in red colour indicates Programming Mode is active. When Programming Mode is activated, the ETS is able to download the physical address.



A blinking red Programming LED indicates the Ethernet cable is not properly connected or no IP network connection is available.



Also when Boot Mode is active, successive pressing the Programming Button will turn on and off Programming Mode and Programming LED.

3.3.2 Physical Address Assignment

To configure the device an interface connection (IP, USB) to the KNX bus system is required. The device is supplied with the individual physical address 15.15.255. The KNX product database entry (available for ETS4 and higher) can be downloaded from the Apricum website and from the KNX Online Catalog.

The physical address can be assigned to the device by setting the desired address in the properties window of the ETS. After starting the ETS download and then pressing the Programming Button the device restarts itself.

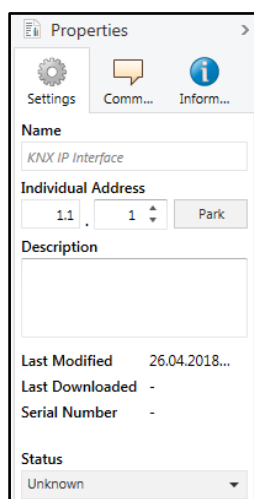

Figure 3: ETS Properties Window



In this document only the term “physical address” is used. The term “physical address” means the KNX physical address as well as the ETS individual address. Both terms are used by the KNX organisation interchangeably.

3.4 Function Button

The Function Button activates UIMip’s special function. Factory Reset can be activated. Device settings of UIMip can be reset to manufacturer default values with the Factory Reset function. During the firmware update procedure the Function Button has to be pressed for Boot Mode activation.

3.4.1 Factory Reset

A long press (≈ 15 sec) of the Function Button soon followed by a short press (≈ 3 sec) executes the Factory Reset. After the first press, the LED display lights like described in Table 3. After the second press, all parameters will be set to factory default (incl. physical address). Subsequently, LEDs indicate normal operation again.

3.4.2 Boot Mode Activation

For Boot Mode activation the firmware update process must be executed. During the process, the Function Button must be pressed to enter Boot Mode (see chapter 5.4).

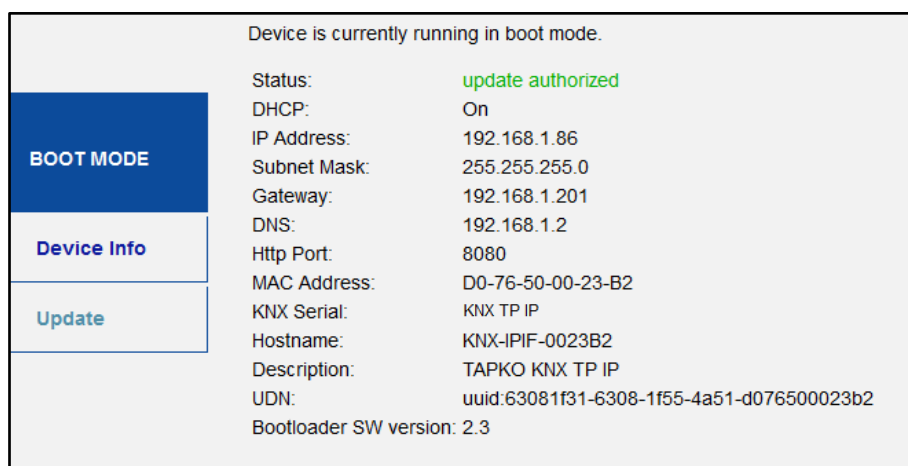

Figure 4: Boot Mode is active

3.4.3 LED Status Display

Table 3: LED Status Display for Factory Reset after first Button Press

Number	LED	Colour	Comment
1	State IP	orange	Lights red if not connected
2	Bus State KNX TP	orange	





Table 4: LED Status Display for Boot Mode

Number	LED	Colour	Comment
1	State IP	green	
2	Bus State KNX TP	blinking green	
3	Telegram Traffic IP	blinking green	not the same tempo as LED2
7	Programming LED	red	



4 ETS Database Parameters

All screen shots are related to the UIMip database file R1-1f in ETS5.

4.1 General

The host name is the name with that the device appears within the Windows network.

Figure 5: General Tab Parameters

Table 5: General Tab Parameter Settings

ETS Parameter	Setting [Factory Default]	Comment
Host name	<30 Characters allowed> [KNX IP Interface]	Field to enter the device name providing an easy search of the device by ETS, by Windows Network and by KNXnet/IP visualisation systems.

4.2 IP Configuration

Here, HTTP port and IP address assignment can be configured.



Figure 6: IP Configuration Tab Parameters, DHCP on

Table 6: IP Configuration Tab Parameter Settings, DHCP on

ETS Parameter	Setting [Factory Default]	Comment
HTTP Port	80 8080 [8080]	Select one of the two official system ports.
DHCP	do not use use [use]	If DHCP is used, no further IP parameters have to be set.

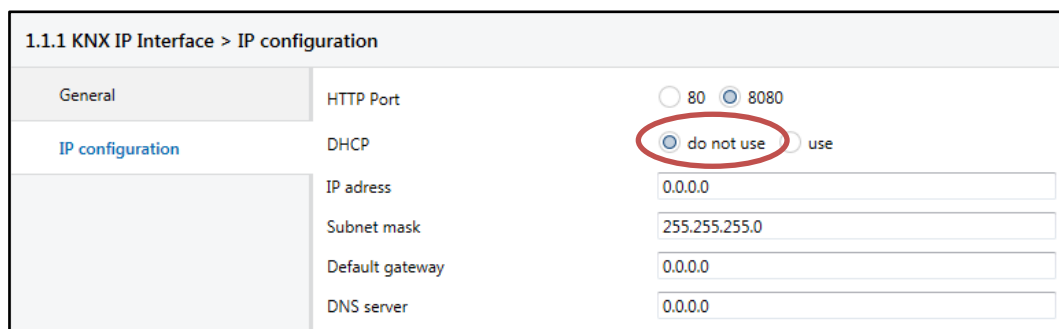

Figure 7: IP Configuration Tab Parameters, DHCP off

Table 7: IP Configuration Tab Parameter Settings, DHCP off

ETS Parameter	Setting [Factory Default]	Comment
IP address	0-255.0-255.0-255.0-255 [0.0.0.0]	IP Byte 1 to 4: manual input.
Subnet mask	0-255.0-255.0-255.0-255 [255.255.255.0]	SM Byte 1 to 4: manual input.
Default gateway	0-255.0-255.0-255.0-255 [0.0.0.0]	DG Byte 1 to 4: manual input.
DNS server	0-255.0-255.0-255.0-255 [0.0.0.0]	DNS Byte 1 to 4: manual input

5 Web Front-end

The web front-end can be used to read out UIMip's actual device parameters (HTTP port, IP address, MAC address, ...), to update its firmware and to adjust the (additional) tunneling addresses. To identify a particular UIMip of a KNX network the Programming LED/Programming Mode can be remotely switched on and off without pressing the on-device Programming Button.



To switch back from Boot Mode to normal operation it is necessary to run the firmware update procedure and then abort, or wait for the 10 min timeout.

5.1 Accessing the UIMip Web Front-end

There are three ways to access the UIMip. It can be accessed like a Microsoft Windows UPnP network device (Windows7 or later) and by a web browser. For access by a web browser either the IP address or the MAC address, together with the HTTP port, have to be known. How to use IP address and MAC address with the browser's URL bar is described in the following.



For access via web browser the HTTP port that is set by ETS (or the factory default parameter value) has to be used.



UIMip is able to use both official HTTP system ports (80 and 8080).



Factory default HTTP port is 8080.

5.1.1 via Windows Network UPnP

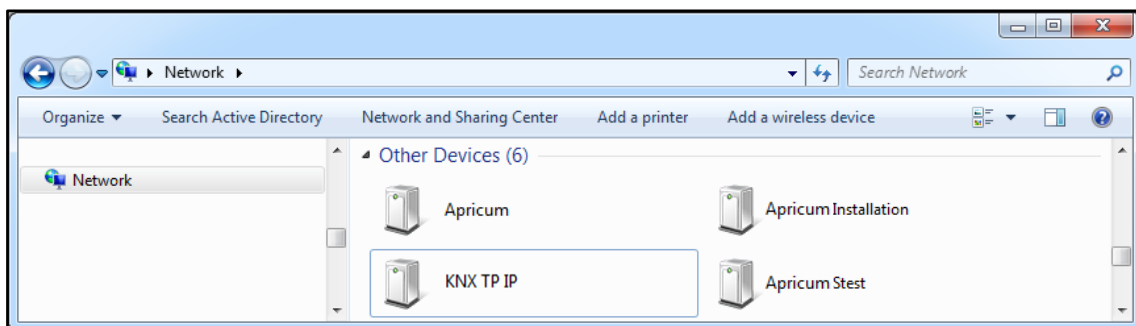

Figure 8: UIMip as UPnP network device ("KNX TP IP")

When the UPnP network function is enabled, UIMip appears in the Windows Network. A click on the UIMip network device opens the web front-end with the standard web browser. If UIMip is not visible as an UPnP network device a manual restart is recommended. After that, the device becomes visible in the list of network devices.

5.1.2 via IP Address

When IP address and HTTP port (80 or 8080) are known, this information is sufficient to access the UIMip web front-end by a web browser. The actual IP address is shown in the ETS list of Discovered Interfaces.

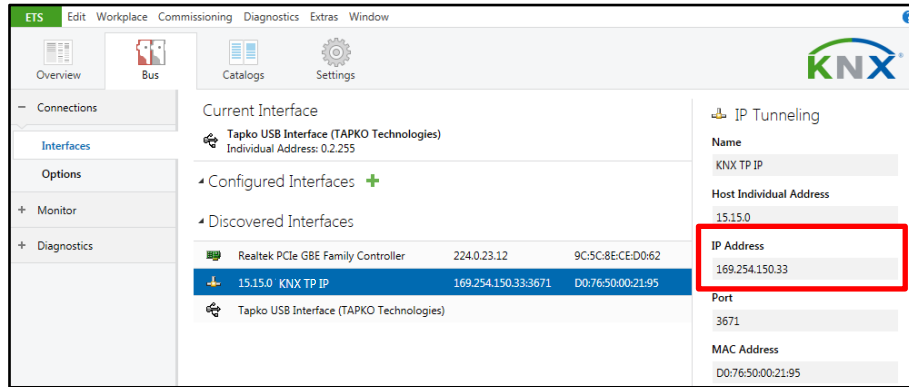

Figure 9: Identifying UIMip’s IP address with ETS

According to UIMip’s pre-set IP configuration (HTTP port, IP address and DHCP, respectively) in the URL bar has to be entered (without brackets):

```
http://[IP address]:[HTTP port]/
```

Example1: DHCP is not used. With the latest ETS download the IP address was set to 192.168.1.32 and HTTP port was set to 80. In the browser’s URL bar has to be entered “http://192.168.1.32:80”.

Example2: With the latest ETS download HTTP port was set to 8080 and DHCP was activated. The DHCP server assigned a free IP address to UIMip and ETS shows this IP address to be 192.168.1.201. In the browser’s URL bar has to be entered “http://192.168.1.201:8080”.

5.1.3 via MAC Address

When NetBIOS is installed (by default on Windows systems and Linux systems containing SAMBA) the MAC address that is printed on a label on the side of the UIMip housing can be used. Due to name resolution is mandatory to establish communication by Host name, activation of NetBIOS is necessary.

Use the MAC address in the form of AA-BB-CC-XX-YY-ZZ and the pre-set HTTP port to be entered in the browser’s URL bar as described here (without brackets):

```
http://knx-ipif-[XXYYZZ]:[HTTP port]/
```

Example: On the housing side UIMip is labelled with MAC address D0-76-50-11-22-33 and the pre-set HTTP port is 8080. Then, in the web browser’s URL bar has to be entered “http://knx-ipif-112233:8080”.

5.2 Device Info

After accessing the web front-end the Device Info tab is shown. All general information about the current device settings is visible.



The screenshot displays the Apricum KNX-IP Interface. At the top left is the Apricum logo, and at the top right is the text 'KNX-IP Interface'. Below this is a navigation menu with three tabs: 'Device Info' (which is selected and highlighted in blue), 'KNX', and 'Update'. The main content area is titled 'Device Information' and lists the following details:

Status:	normal operation
DHCP:	true
IP Address:	192.168.1.32
Subnet Mask:	255.255.255.0
Gateway:	192.168.1.201
DNS:	192.168.1.2
Http Port:	8080
MAC Address:	D0-76-50-00-0B-83
Hostname:	KNX-IPIF-000B83
Description:	UIM KNX IP Interface
UDN:	uuid:5f42333a-6308-1f55-4a51-d07650000b83
Application SW version:	2.0.3
Bootloader SW version:	2.2

Figure 10: Device Info Tab

5.3 KNX

Here, all KNX specific addresses are shown. Setting changes can easily be checked. With a simple click on “On” or “Off” Programming Mode can be switched on/off. This function is equivalent to a Programming Button press. Together with the Device Info tab it is easy to distinguish the regarded device (with a certain IP address or MAC address or serial number) from other similar devices in the same IP network.

Four tunneling addresses can be set. ETS sets the first tunneling address. With a click on “Set” the remaining ones are set. Moreover, routing multicast address and serial number of the device are shown.

Device Info	Program Mode: Off
KNX	Change Program Mode: <input type="button" value="ON"/> <input type="button" value="OFF"/>
Update	Individual Address 15.15.0
	15.15.241
	Tunneling Addresses 15.15.242
	15.15.243
	15.15.244
	Set Tunneling Addresses <input type="button" value="Set"/>
	Routing Multicast Address 224.0.23.12
	Serial Number 0072-7005401F

Figure 11: KNX Tab



The web browser used has to support SVG graphics.

5.4 Firmware Update / Boot Mode

Under the Update tab the UIMip firmware can be updated via IP i.e. the Ethernet network like described in following steps. During the remote update process UIMip enters Boot Mode. Then LEDs 1, 2, 3, and 7 light as described in Table 3.



If Boot Mode is already active only the web front-end instructions from step 3 to step 5 must be followed (refresh, request update).



Boot Mode is still active after device reset and after factory reset.

To exit Boot Mode it is necessary to enter the Update tab of the web front-end. Then either the firmware update has to be completed (if a new firmware is available) or the firmware update process has to be stopped by a click on the “Abort” button. After that UIMip restarts and continues with normal operation.

Step 1: Open the Update tab of the web front-end.

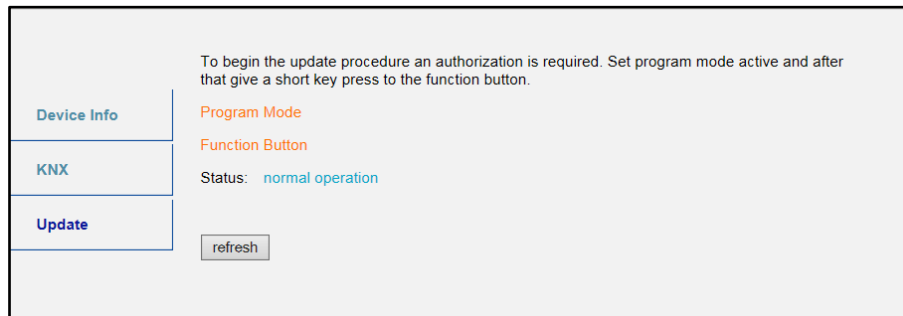

Figure 12: Update Tab

Step 2: Activate Programming Mode (KNX tab or Programming Button).

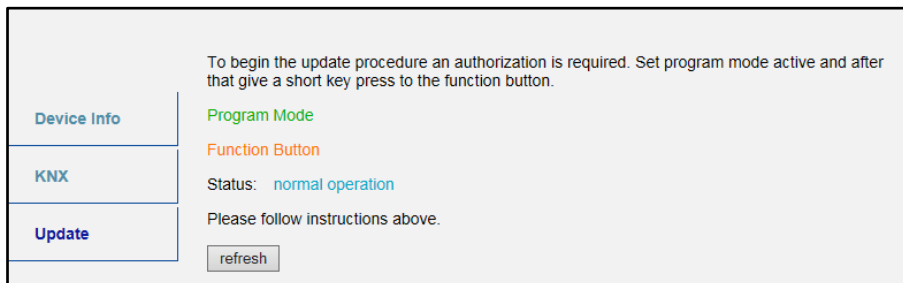

Figure 13: Update Tab and activated Programming Mode

Step 3: After Programming Mode activation give a short press to the Function Button. Then click on the “refresh” button (alternatively, refresh the browser).

The screenshot shows a web interface with a sidebar on the left containing three menu items: 'Device Info', 'KNX', and 'Update'. The 'Update' menu item is highlighted. The main content area displays the following text: 'Authorization valid. Please continue update procedure within 10 minutes.' Below this, there are two green links: 'Program Mode' and 'Function Button'. The status is shown as 'update authorized' in green. A message says 'Please press button below to continue.' followed by a 'refresh' button.

Figure 14: Update Authorized

Step 4: When the „request update“ button appears it has to be pressed to select the update file and enter “Boot Mode”.

The screenshot shows the same web interface as Figure 14. The main content area displays: 'Requesting an update sets the device to boot mode and suspends KNX-IP communication. Otherwise the device will log out automatically after 10 minutes.' Below this, the 'Device Mode' is 'update authorized' in green. A 'Timeout: 8 min' is shown. A message says 'Please press button below to continue.' followed by a 'request update' button.

Figure 15: Request Update

Step 5: The update file can be selected and uploaded. Clicking on the „Abort“ button cancels the firmware update procedure and the device exits Boot Mode.

The screenshot shows the web interface in 'BOOT MODE'. The main content area displays: 'To initiate a firmware update please select a valid file in hex-format below. Otherwise the device will log out automatically after 10 minutes.' The status is 'update authorized' in green. There is a text input field for 'Select update file:' with a 'Durchsuchen...' button to its right. Below the input field are three buttons: 'Upload', 'Abort', and 'Abort'.

Figure 16: Select Update File

5.5 IP Tunneling Address Assignment

According to the host's physical address assignment the first tunneling address (additional physical address) of the UIMip can only be set by ETS.



Please make sure: The additional physical addresses for tunneling and the host's physical address have to be different.

- Step 1:** Open the ETS Bus tab and select UIMip as the "Current Interface". In the "IP Tunneling" window the already assigned host physical address can be read.

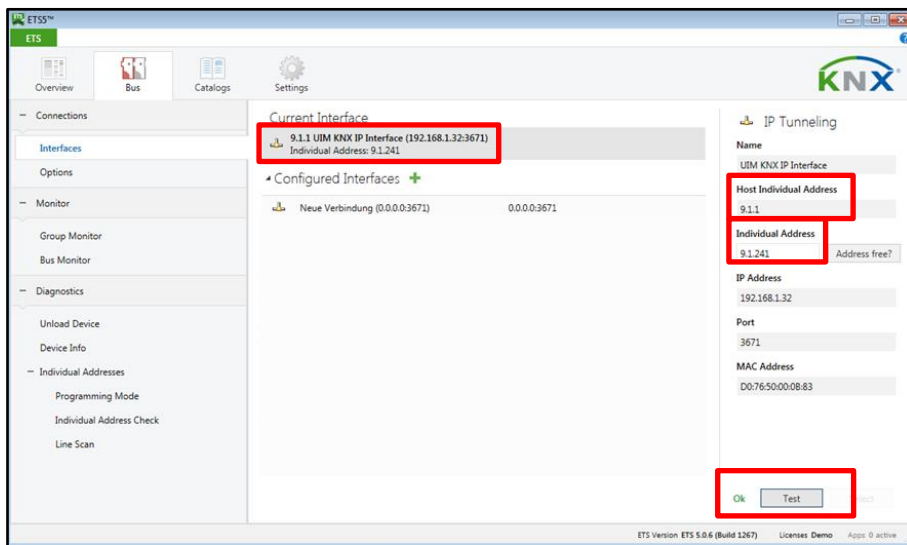

Figure 17: First Additional Physical Address (First Tunneling Address) Assignment

- Step 2:** Set the first additional physical address by the "Individual Address" field. Click on the "Test" button. If the green **Ok** appears, the first tunneling address is set. In this example it is "9.1.241".

- Step 3:** Now open the KNX tab of the web front-end. Click on the "Set" button to set the remaining three tunneling addresses basing on the first tunneling address as follows.

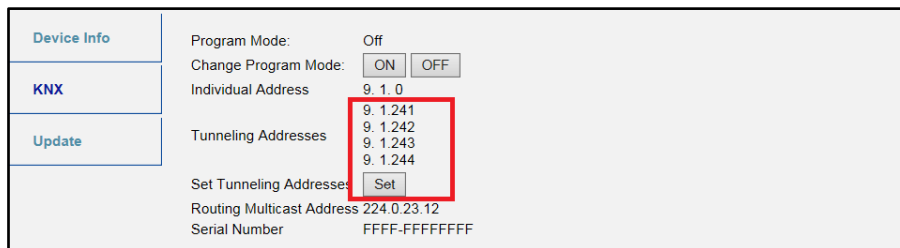

Figure 18: Additional Tunneling Address Assignment in the Web Front-end

6 State of Delivery

6.1 Default Factory Setting

Table 8: Default Factory Setting

General	
Product	KNX IP Interface
Physical Address	15.15.0
Tunneling Addresses	<ul style="list-style-type: none">• 15.15.241• 15.15.242• 15.15.243• 15.15.244
IP configuration	
IP address assignment	DHCP/AutoIP

6.2 Technical Datasheet

Marking/Design	UIMip
Current consumption	< 20 mA
Connections	IP (line): RJ45 socket for 100 Mbit and 10 Mbit BaseT, IEEE 802.3 networks KNX TP line: KNX TP connector (red/black), screwless, for single-core cable Ø 0.6...0.8 mm
LED Display elements	State (IP and TP) Traffic (IP and TP) Programming LED
Control elements	Function Button Programming Button
Mounting	35 mm top-hat rail (TH35) according to IEC60715
Protection type	IP20 according to IEC60529
Pollution degree	2 according to IEC60664-1
Protection class	III according to IEC61140
Overvoltage category	II according to IEC60664-1
Approbation	KNX-certified according to ISO/IEC14543-3
CE Marking	In compliance with directives 2014/35/EU (LVD), 2014/30/EU (EMC), 2011/65/EU (RoHS)
Standards	EN50491-5-1, EN50491-5-2, EN50491-5-3, EN50581, EN60950-1, EN61000-6-2, EN61000-6-3, IEC60950-1
Voltage supply	KNX: 21...30V DC (SELV)
Housing colour	Plastic PA66 housing, grey
Housing dimensions	H = 90 mm, W = 36 mm (2 modules), D = 71 mm
Mounting depth	64 mm
Weight	68 g
Operating temperature	-5...45 °C
Storage temperature	-20...60 °C
Ambient humidity	5...93 %, non-condensing

6.3 Technical Drawings



All dimensions shown here are specified in mm.



The total device width is 2 modules at 18 mm.

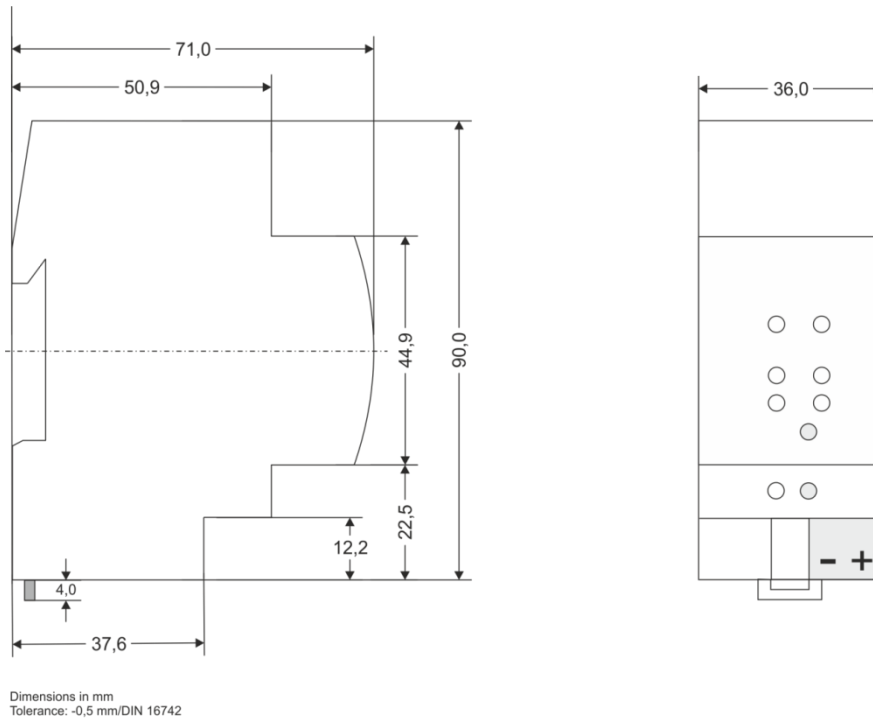

Figure 19: Dimension drawings

7 Legal Notice



Lw IP is used in developing the UIMip.



Lw IP is licenced under the BSD licence.

Copyright (c) 2001-2004 Swedish Institute of Computer Science. All rights reserved.

Providing that the following conditions are met redistribution and use in source and binary forms, with or without modification, are permitted:

- Redistributions of the source code must retain the above copyright notice, this list of conditions and the following disclaimer.
- Redistributions in binary form must reproduce the above copyright notice, this list of conditions and the following disclaimer in the documentation and/or other materials provided with the distribution.
- The name of the author may not be used to endorse or promote products derived from this software without specific prior written permission.

THIS SOFTWARE IS PROVIDED BY THE AUTHOR ``AS IS AND ANY EXPRESS OR IMPLIED WARRANTIES, INCLUDING, BUT NOT LIMITED TO, THE IMPLIED WARRANTIES OF MERCHANTABILITY AND FITNESS FOR A PARTICULAR PURPOSE ARE DISCLAIMED. IN NO EVENT SHALL THE AUTHOR BE LIABLE FOR ANY DIRECT, INDIRECT, INCIDENTAL, SPECIAL, EXEMPLARY, OR CONSEQUENTIAL DAMAGES (INCLUDING, BUT NOT LIMITED TO, PROCUREMENT OF SUBSTITUTE GOODS OR SERVICES; LOSS OF USE, DATA, OR PROFITS; OR BUSINESS INTERRUPTION) HOWEVER CAUSED AND ON ANY THEORY OF LIABILITY, WHETHER IN CONTRACT, STRICT LIABILITY, OR TORT (INCLUDING NEGLIGENCE OR OTHERWISE) ARISING IN ANY WAY OUT OF THE USE OF THIS SOFTWARE, EVEN IF ADVISED OF THE POSSIBILITY OF SUCH DAMAGE.

8 FAQ

- **The firmware update finished successfully but the device doesn't work.**
To restart turn the power off and on again (dis-/reconnection of KNX TP line).
- **Is it Ok to connect and disconnect the Ethernet cable quickly?**
No! Don't do this. Before reconnection, wait for a few seconds.
- **What shows the Programming LED if the Ethernet cable is not connected?**
Similar to having no IP network available, the Programming LED is blinking red.
- **LED 2 Bus State KNX TP is continuously blinking green. Why?**
This indicates UIMip is in Boot Mode. For more information and how to switch back to normal operation please refer to chapter 5.4.
- **I disabled DHCP and assigned a correct IP configuration, but I cannot access the web front-end. Why?**
Reset the UIMip and try again. More information about changing the IP network configuration can be found in chapter 4.2.
- **I try to access the web front-end but I'm not successful. What can I do?**
Make sure the URL bar entry matches the correct IP address together with the right HTTP port or use the MAC address in exactly the way as explained (chapter 5.1). Then wait for about 5 or 10 seconds, refresh the browser and try again.
- **Is it possible to reach the web front-end when the device is in Boot Mode?**
Yes, it is. The web front-end is accessible also in Boot Mode (chapter 5.4). When Boot Mode is active, the web front-end looks like illustrated in figure 4. To run a firmware update procedure and/or exit Boot Mode the web front-end Update tab must be used. Otherwise, after 10 min Boot Mode will be switched off automatically.
- **I was able to reach the web front-end. But when I try to use its tabs or buttons my browser only shows a connection error to me. What can I do?**
Refresh the browser window. The web front-end will show up again.
- **How can I find out the actual IP address of my UIMip?**
The Device Info tab of the web front-end and the list of Discovered Interfaces in ETS both show the actual IP address.

UIMip

Product:

KNX IP Interface

Doctype:

Technical & Application Description

Release Number / Release Date:

R1.4 / May 2020

Editor:

Peter Hauner

Web:

www.apricum.com/uimip

Contact:

apricum@apricum.com

Telephone:

+385 21 507600